

Noise analysis, then and today

Dr. Ulrich L. Rohde

Introduction:

Noise analysis of autonomous circuits (oscillators) was a dream since many years. The first and linear approach has to be credited to David Leeson, who took a linear low pass equivalent circuit and derived his frequently quoted linear type formula [1]. This formula requires data which really can only be gained after a post prior analysis. The values of the output power, the loaded Q, the large signal noise factor {frequently confused with noise figure, $NF=10 \times \log(\text{noise factor})$ } and the flicker noise contribution are not known a priori. A complete computation of these values is found in [2, pp 131-137]. The introduction of the nodal noise analysis in a proper way was published by Hillbrand and Russer [3]. The Lee-Hajimiri noise analysis is interesting but not very practical. It is quoted very often in the literature but its use is not practically shown. [2, pp 137-139, 4, 5, 6].

If we combine the Leeson formula with the tuning diode contribution, the following equation allows us to calculate the noise of the oscillator completely [2, pp 129]. The VCO term was added by Rohde [2, pp 131] and the flicker term was added by Scherer [7]

$$L(f_m) = 10 \log \left\{ \left[1 + \frac{f_0^2}{(2f_m Q_0)^2 m^2 (1-m)^2} \right] \left(1 + \frac{f_c}{f_m} \right) \frac{FkT}{2P_{sav}} + \frac{2kTRK_0^2}{f_m^2} \right\} \quad (1)$$

where

$L(f_m)$ = ratio of sideband power in a 1 Hz bandwidth at f_m to total power in dB

f_m = frequency offset

f_0 = center frequency

f_c = flicker frequency

Q_L = loaded Q of the tuned circuit

Q_0 = unloaded Q of the tuned circuit

$m = (Q_L/Q_0)$

F = noise factor

$kT = 4.1 \times 10^{-21}$ at 300 K₀ (room temperature)

P_{sav} = average power at oscillator output

R = equivalent noise resistance of tuning diode (typically 50 Ω - 10 kΩ)

K_0 = oscillator voltage gain

Kaertner's paper [8] used a nice time domain approach and includes, probably for the first time, the noise correlation in oscillator design. At his time the now available harmonic balance method was not invented. A very good description is found in the works by Rizzoli [9-11]. While not easy to read and highly mathematical, Kaertner's calculation produced very real results.

Large signal noise analysis:

The introduction of the "piece wise linear" harmonic balance (HB) method, which for the first time ever, was developed by Prof. Vittorio Rizzoli and team, was the perfect body to include the noise correlation method. The famous nonlinear time domain based circuit analysis program SPICE lacks a rigorous noise correlation analysis and the harmonic balance programs are a hybrid of linear (frequency) and nonlinear

(time domain) computations [12, 13]. Rowan Gilmore worked with me during our ‘Compact Software’ time. Both publications by Rizzoli and Gilmore were leading on the topic.

My team at ‘Compact Software’ and the Rizzoli team were a bit struggling to validate the results and it was complicated to get reliable measured data and maintain accuracy and speed. The Compact Software approach and the Rizzoli team were always fighting with this topic. I remember telling users that short cuts used in some programs were getting them faster to the wrong answer. At the end, a very fast double precision multidimensional matrix inversion program that had to be developed was the solution. The use of FORTRAN gave the most stable results. This HB approach is also able to deal with hysteresis.

The first and most challenging circuit analysis of a low noise Raytheon-developed amplifier circuit was published and the details of which can be found in [14 pp 376-379]. For the first time ever and in cooperation with Robert (Bob) Pucell (Raytheon) and Tony Pavio (TI), we demonstrated very accurate results using SPICE type data for GaAs FET’s. They were hard to come by. We ended up using a modified Materka model. [15-19]. Actual circuit was published in The Microwave Journal [20]. So far I have demonstrated that the noise-analysis can be done based solely on the available accurate SPICE parameters of GaAs-FET and its family members.

But the really needed large signal circuit analysis was the one of the oscillator. To implement the proper FET [15-19] and BIP [20, 21, 22] models and its derivatives was quite a task. The internal noise modeling was based on the noise correlation matrix [2] and the results were published by W. Anzill, F.X. Kaertner, P. Russer, in 1992 [23]. Since 1987 the Microwave Harmonica program by Compact Software was already proven to be reliable [see 20]. The next step of course was to match the measured results of practical circuits. Hewlett Packard had the first and reliable phase noise system and Dieter Scherer was the lead engineer at the time to educate us all. For a systematic approach, even without a simulator, as shown in [24], it is useful to have large-signal S-parameters. They are defined in [2, pp 63]. Today the leading Phase Noise Analyzer is the Rohde and Schwarz Model – FSWP/8/26/50.

As to the Large-Signal parameters of bipolar transistors, which at the time of Kaertner’s times had not been derived, they are best obtained from measurements. More about the topic is found in [24].

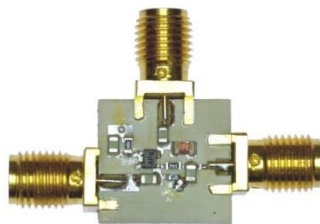

Figure 1: Test fixture to measure large signal S-parameters

The proper de-embedding procedure needed has been shown in [19]. It translates the external measurements to the actual chip.

For the actual measurement a Network Analyzer is necessary with variable output power.

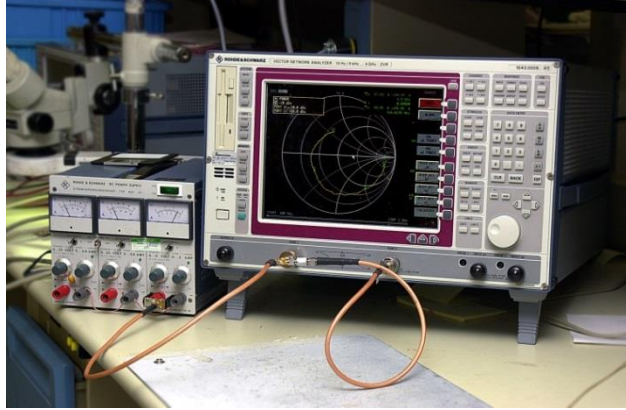

Figure 2: Rohde & Schwarz 3 GHz network analyzer to measure the large-signal S-parameters at different drive levels.

Large signal operation of a transistor means not the customary low-noise application. The Large-signal operation makes the BJT behave differently than expected [18-22].

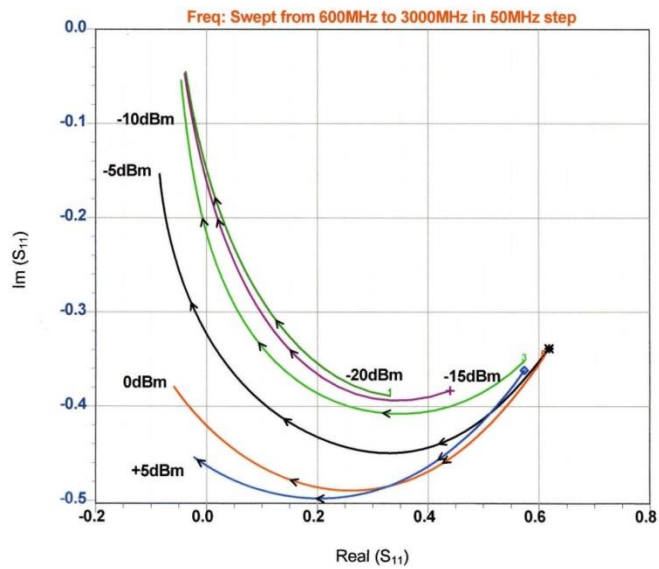

Figure 3: Measured large-signal S_{11} of the Infineon BFP520

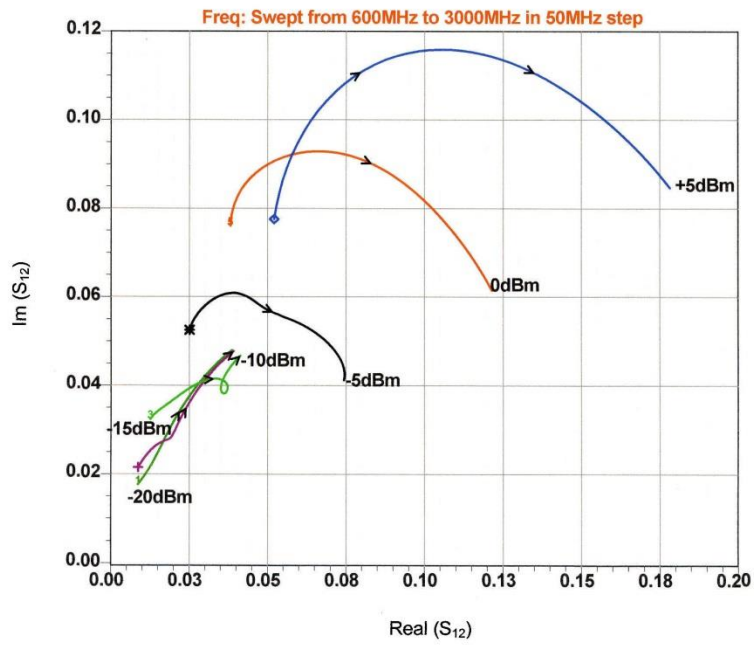

Figure 4: Measured large-signal S_{12} of the Infineon BFP520

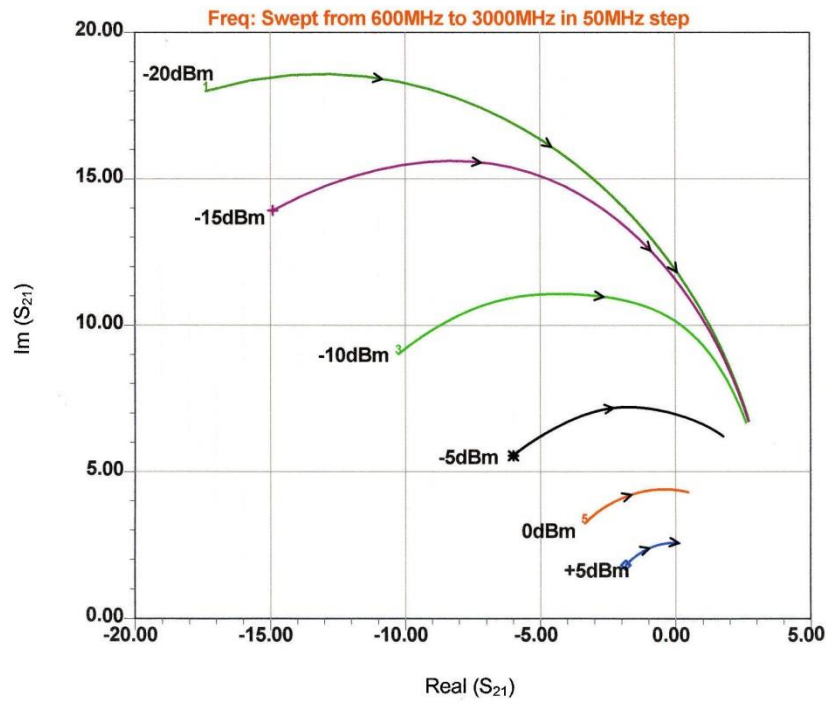

Figure 5: Measured large-signal S_{21} of the Infineon BFP520

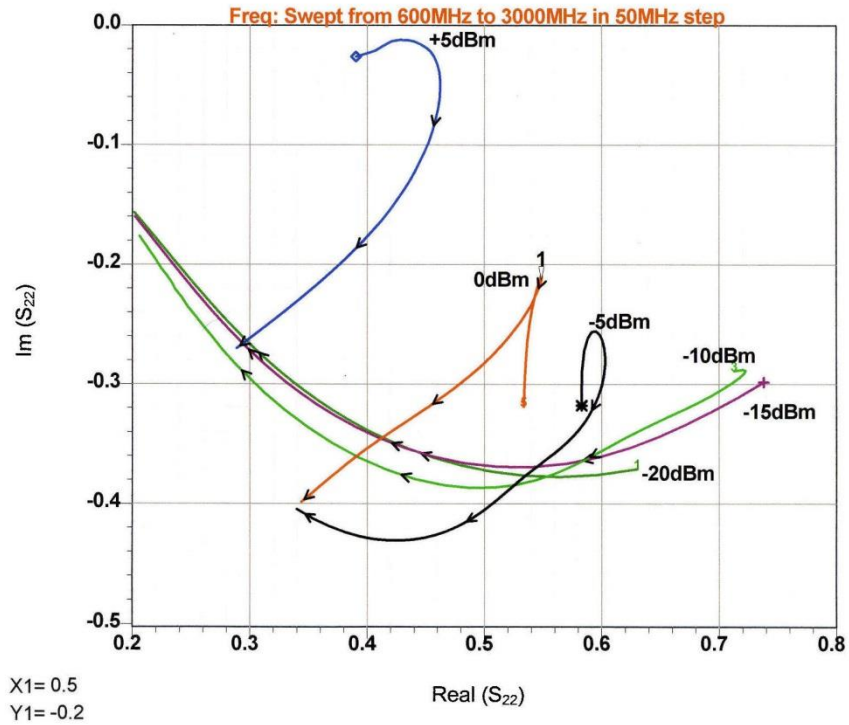

Figure 6: Measured large-signal S_{22} of the Infineon BFP520

From Figures 4 and 6 it is clearly obvious that this is Large-Signal Operation [25].

So, after all this information I would like to analyze the circuit which was used by Kaertner as the basis of his brilliant paper [8, 23]. The values shown below are taken from his publication.

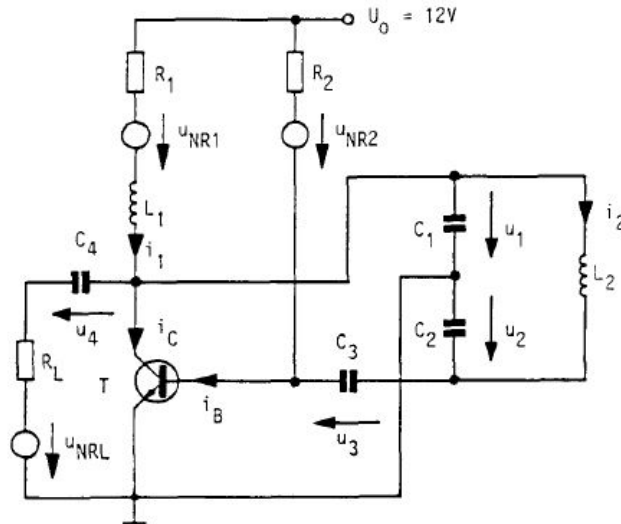

Figure 7: Colpitts Oscillator analyzed by Kaertner

The values of the components are $R_1=350\Omega$, $R_2=110k\Omega$, $R_L=500\Omega$, $L_1=10\mu H$, $L_2=30nH$, $C_1=10pF$, $C_2=940pF$, $C_3=2.7nF$, $C_4=1.5nF$, $T=BFR35A$

Kaertner made one simplification which in actual circuit theory is deadly; L2 was assumed to have infinite Q. For his approach, as the circuit will actually load the unloaded Q, this is permissible. With an infinite Q and with C2= 940 pF it will oscillate. Once a real Q like QL=100 is used and the value of C2 has to be reduced to a 100 pF and then all works well. The feedback has to be increased. It is also advisable to reduce C4 to 100pF as it is not possible to make a capacitor without parasitic inductance. The same applies to the 10uH inductor, which is probably resonant at the operating frequency, and 1uH seems to be a better choice.

Kaertner published the calculated phase noise as shown in figure 7 of his paper [4]. He pointed out correctly that the flicker contribution was not included.

In using the Compact Software “Microwave Harmonia” (referring to harmonic balance techniques), here is an adaption of his circuit.

Kaertner :Determination of the Correlation Spectrum , F= 300MHz

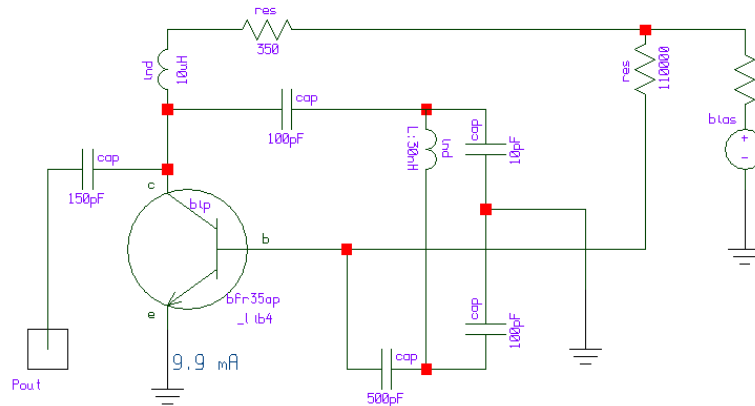

Figure 8: Circuit schematic of the Kaertner 300MHz Oscillator

The simulation: now including the AF and KF values, provides results tracking Kaertner’s publication.

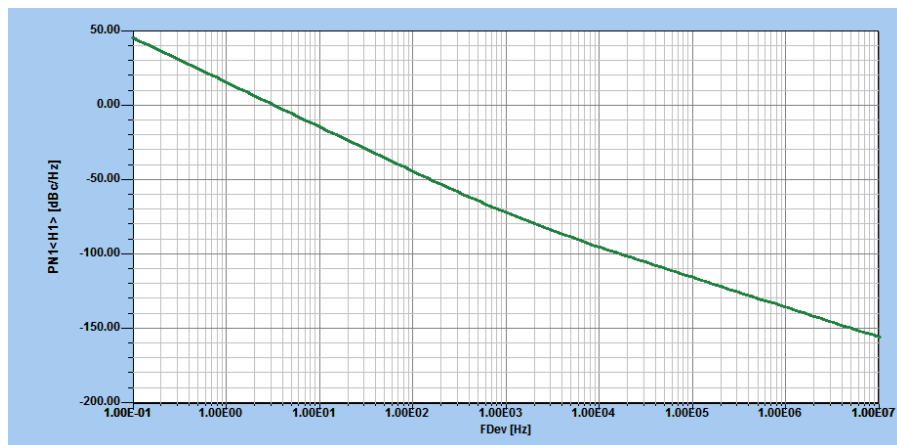

Figure 9: Simulated Phase Noise of the Kaertner Oscillator (Fig 8)

The influence of AF and KF is clearly seen at 1 kHz. Finally, here is the prediction of the output power and the harmonic contents.

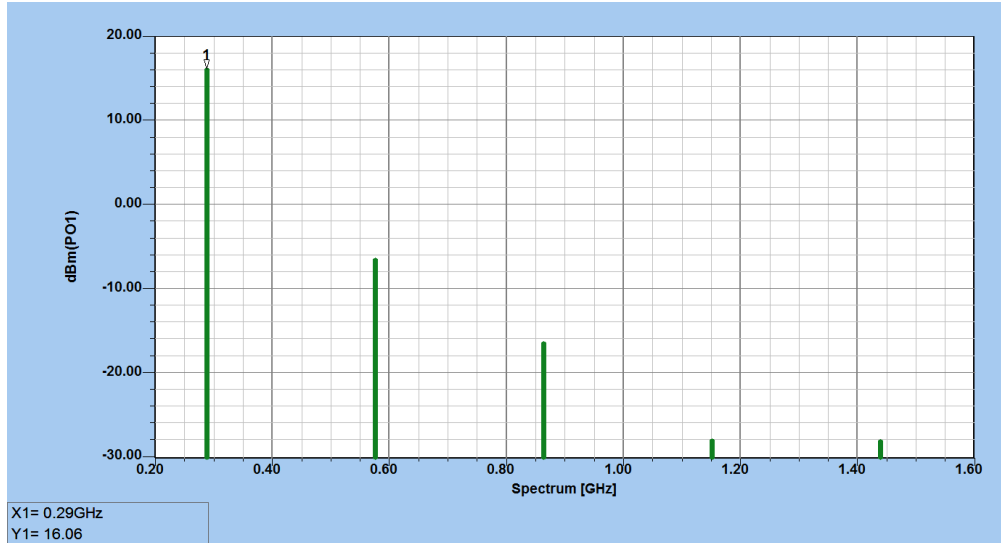

Figure 10: Simulated Output Power of the Kaertner Circuit

The output power is about 16dBm and the harmonic suppression is about 20dB. This indicates a good operating Q of the resonant circuit.

All this tracks very well.

Here are some additional thoughts regarding my paper which may be useful for clarification and of interest.

Although Leeson's phase-noise model provides a valuable insight into the oscillator design from engineering perspectives, it cannot explain some of the important phase noise phenomena. This is due to simplifying assumptions made about the linearity and time-invariant behavior of the system. When comparing the measured results of oscillators with the assumptions made in Leeson's Equation, one frequently obtains a *de facto* noise figure in the vicinity of 20 to 30 dB and an operating Q that is different than the assumed loaded Q, therefore must be determined from measurement; diminishing the predictive power of the Leeson's phase noise.

Leeson's model observes the asymptotic behavior of phase-noise at close-to carrier offsets, asserting that phase-noise goes to infinity with $1/f^3$ rate. This is obviously wrong as it implies an infinite output power for oscillator. For noisy oscillators it could also suggest that $L(f) > 0$ dBc/Hz, this singularity arises from linearity assumption for oscillator operation around steady-state point. In fact, the linear model breaks down at close-to-carrier frequencies where the phase-noise power is strong [5]. Considering a nonlinear model for the oscillator in absence of flicker noise, these singularities can be resolved by expressing the phase noise in the form of a Lorentzian function [4]

$$L(\Delta f_m) \propto \frac{a^2}{a^2 + (\Delta f_m)^2} \quad (1)$$

where a is a fitting parameter.

Although Equation (1) models the spectrum and avoids any singularity at $\Delta f_m=0$ while maintaining the same asymptotic behavior as illustrated in Figure 1; this is an after-the-fact approach, not a predictive one. From Equation (1), the total power of phase-noise from minus infinity to plus infinity is 1, this means that phase-noise doesn't change the total power of the oscillator; it merely broadens its spectral peak. Attempting to match the Leeson calculated curve "A" (Figure 1), the measured curve requires totally different values than those assumed due to up-conversion and down-conversion of noise

components from harmonically related frequencies to around carrier frequency as depicted in (Figure 2) [5].

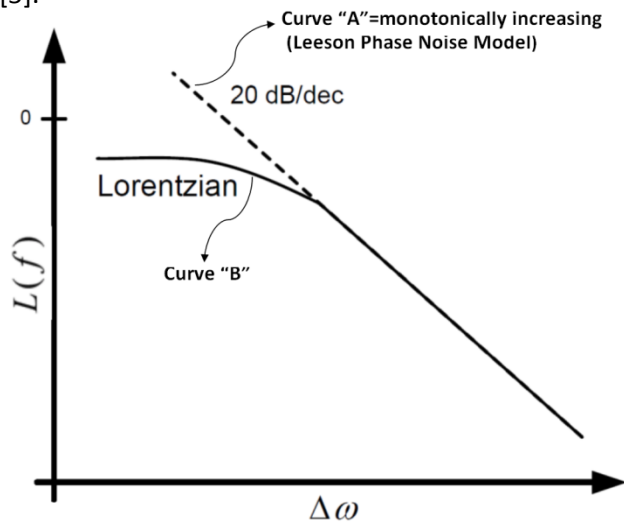

Figure 1: Close-In phase-noise behavior due to white noise sources. Leeson’s model predicts phase-noise monotonically increases by approaching the carrier whereas in reality it takes the form of a Lorentzian shape [4]

Particularly, the effect of the low-frequency flicker noise components on close-in phase-noise is not well characterized in Leeson’s model. The model asserts that the phase-noise $1/f^3$ corner frequency is exactly equal to the amplifier’s flicker-noise corner frequency, ω_c . However, measurements frequently show no such equality. This is because Leeson models the oscillator as a time-invariant system, whereas oscillators are in general cyclostationary (A cyclostationary process is a signal having statistical properties that vary cyclically with time) time-varying systems due to the presence of the periodic large-signal oscillation. This issue has been addressed by several authors. Hajimiri has shown that the oscillator’s phase-noise $1/f^3$ corner frequency can be significantly lower than the device’s flicker corner frequency; provided that the oscillation signals at the output of the oscillator circuits is odd-symmetric [6].

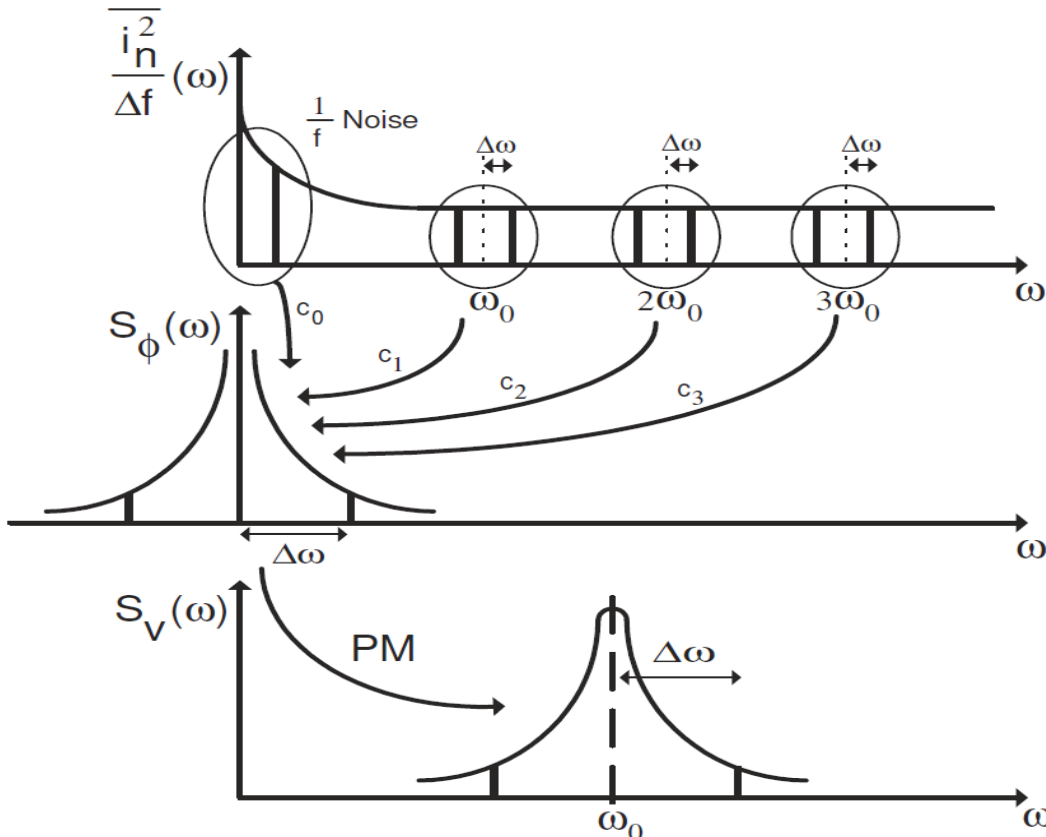

Figure 2: Conversion process from noise ($S_n(\omega)$) to phase-noise ($L(\omega)$). Noise components from harmonically-related frequencies are up/down-converted to around carrier phase noise, Leeson's model fails to address this phenomenon [6].

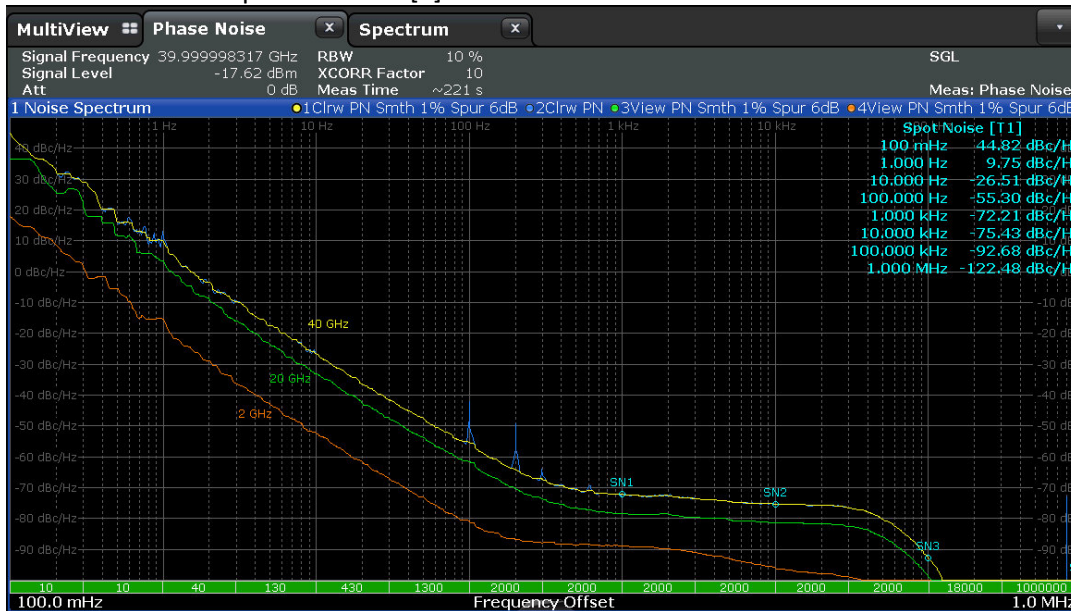

Figure 3: Measurement of a 40GHz source where the spot noise is larger than zero
 Note: For large phase variations ($\gg 1$ radian rms/rt Hz), $S_\Phi(f)$ will be greater than 0 dB. For small phase variations (< 1 radian rms/rt Hz), $S_\Phi(f)$ will be less than 0 dB. $S_\Phi(f)$ is a very useful for analysis of the effects of phase noise on systems that have phase sensitive circuits, such as digital communications

links. This historical definition of phase noise is confusing when the phase variations exceed small values because it is possible to have phase noise values that are greater than 0 dB even though the power in the modulation sideband is not greater than the carrier power.

Quantifying Phase Noise

Due to the random nature of the instabilities, the phase deviation is represented by a spectral density distribution plot. The term spectral density describes the power distribution (mean square deviation) as a continuous function, expressed in units of energy within a given bandwidth. The short term instability is measured as low-level phase modulation of the carrier and is equivalent to phase modulation by a noise source. There are four different units used to quantify spectral density:

$S(f)$, $L(f)$, $S_{\Phi}(f)$, and $S_y(f)$.

A measure of phase instability often used is $S_{\Phi}(f)$, the spectral density of phase fluctuations, on a per Hertz basis. If we demodulate the phase modulated signal, using a phase detector, we obtain V_{out} as a function of phase fluctuations of the input signal. Measuring V_{out} on a spectrum analyzer gives $\Delta V_{rms}(f)$ which is proportional to $\Delta\Phi_{rms}(f)$

$$S_{\Phi}(f) = \frac{\Delta\Phi_{rms}^2(f)}{K_{\Phi}^2 B} = \frac{S_{V,rms}(f)}{K_{\Phi}^2} \left[\frac{rad^2}{Hz} \right]$$

The term spectral density describes the energy distribution as a continuous function, expressed in units of phase variance (radians) per unit bandwidth. If we use 1 radian(rms)/rt Hz as the phase variance comparison, we can express $S_{\Phi}(f)$ in terms of dB.

For large phase variations ($\gg 1$ radian rms/rt Hz), $S_{\Phi}(f)$ will be greater than 0 dB. For small phase variations (< 1 radian rms/rt Hz), $S_{\Phi}(f)$ will be less than 0 dB.

$S_{\Phi}(f)$ is a very useful for analysis of the effects of phase noise on systems that have phase sensitive circuits, such as digital communications links.

$L(f)$ is an indirect measure of noise energy easily related to the RF power spectrum observed on a spectrum analyzer. The historical definition is the ratio of the power in one phase modulation sideband per hertz, to the total signal power. $L(f)$ is usually presented logarithmically as a plot of phase modulation sidebands in the frequency domain, expressed in dB relative to the carrier power per hertz of bandwidth [dBc/Hz].

This historical definition of phase noise is confusing when the phase variations exceed small values because it is possible to have phase noise values that are greater than 0 dB even though the power in the modulation sideband is not greater than the carrier power.

IEEE STD 1139 has been changed to define $L(f)$ as $S_{\Phi}(f)/2$ to eliminate the confusion.

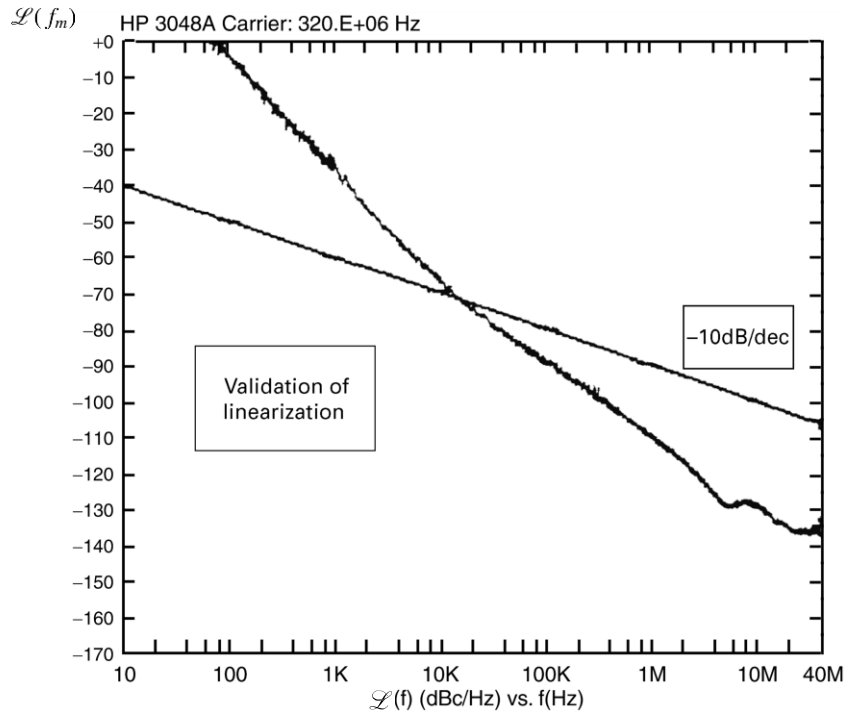

Figure 4: Indication of the range of validity of phase noise measurements, not spectral density. The measured value above the solid line is invalid.

Extended References:

[1] Ulrich Rohde, Ajay Poddar, Anisha Apte, “ How Low Can They Go, Oscillator Phase noise model, Theoretical, Experimental Validation, and Phase Noise Measurements”, IEEE Microwave Magazine , Vol. 14, No. 6, pp. 50-72, September/October 2013

[2] U.L. Rohde, A.K. Poddar, and G. Boeck, “The Design of Modern Microwave Oscillators for Wireless Applications: Theory and Optimization”, Wiley, New York, 2005

[3] http://www.keysight.com/upload/cmc_upload/All/PhaseNoise_webcast_19Jul12.pdf

[4] <http://mathworld.wolfram.com/LorentzianFunction.html>

[5] M. Nick, “New Q-Enhanced Planar Resonators for Low Phase-Noise Radio Frequency Oscillators”, PhD Dissertation, Electrical Engineering, University of Michigan, 2011

[6] A. Hajimiri and T. H. Lee, “A general theory of phase noise in electrical oscillators,” *IEEE J. Solid-State Circuits*, vol. 33, no. 2, pp. 179-194, Feb. 1998

Summary:

This brief history and summary paper provides some insight in the struggle to develop a general purpose non-linear CAD tool that predicts large-signal noise in amplifiers, frequency doublers and mixer circuits, correctly, including its validation. Many more examples are found in [2, 14].

As outlined there were many excellent contributors. Prof. Vittorio Rizzoli probably made the most contribution, and the effort for testing and validation of the Serenade Harmonica program that my team provides must not be underestimated.

Later, a CAD independent mathematical time-domain calculation was developed, which, without immediately resorting to an expensive tool, can predict the noise performance of oscillators. [2, 23, 24]

References:

- [1] D.B. Leeson, "A Simple Model of Feedback Oscillator Noise Spectrum," Proceedings of the IEEE, Vol. 54, pp. 329–330, 1966. (Volume: 54, Issue:2, Feb. 1966)
- [2] Ulrich L. Rohde, Ajay K. Poddar, Georg Böck, The Design of Modern Microwave Oscillators for Wireless Applications: Theory and Optimization, pp 131-137
- [3] H. Hillbrand, P. Russer, "An efficient method for computer aided noise analysis of linear amplifier networks", IEEE Transactions on Circuits and Systems (Volume: 23, Issue: 4, Apr 1976)
- [4] Lee, A. Hajimiri, "Linearity, Time Variation, and Oscillator Phase Noise", in RF and Microwave Oscillator Design, ed. M. Odyniec, Artech House, 2002.
- [5] A. Hajimiri, T. Lee, "A General Theory of Phase Noise in Electrical Oscillators," IEEE Journal of Solid-State Circuits, Vol. 33, No. 2, pp. 179–194, February 1998.
- [6] D. Ham, A. Hajimiri, "Concepts and Methods in Optimization of Integrated LC VCOs," IEEE Journal of Solid-State Circuits, June 2001.
- [7] Dieter Scherer, "Design Principles and Test Methods for Low Phase Noise RF and Microwave Sources", RF and Microwave Measurement Symposium and Exhibition, Hewlett-Packard, 1983
- [8] FRANZ X. KAERTNER, "Determination of the Correlation Spectrum of Oscillators with Low Noise", IEEE TRANSACTIONS ON MICROWAVE THEORY AND TECHNIQUES, VOL. 37, NO. 1. JANUARY 1989
- [9] V. Rizzoli, F. Mastri, C. Cecchefti, "Computer-Aided Noise Analysis of MESFET and HEMT Mixers," IEEE Transactions on Microwave Theory and Techniques, Vol. MTT- 37, pp. 1401–1410, September 1989.
- [10] V. Rizzoli, A. Lippadni, "Computer-Aided Noise Analysis of Linear Multiport Networks of Arbitrary Topology," IEEE Transactions on Microwave Theory and Techniques, Vol. MTT-33, pp. 1507–1512, December 1985.
- [11] V. Rizzoli, F. Mastri, D. Masotti, "General-Purpose Noise Analysis of Forced Nonlinear Microwave Circuits," Military Microwave, 1992.
- [12] R.J. Gilmore, M.B. Steer, "Nonlinear Circuit Analysis Using the Method of Harmonic Balance—A Review of the Art. Part I. Introductory Concepts," International Journal of Microwave and Millimeter-Wave Computer-Aided Engineering, Vol. 1, No. 1, pp. 22–37, January 1991.
- [13] R.J. Gilmore, M.B. Steer, "Nonlinear Circuit Analysis Using the Method of Harmonic Balance—A Review of the Art. Part II. Advanced Concepts," International Journal of 367T.
- [14] Ulrich L. Rohde, David P. Newkirk, "RF/Microwave Circuit Design for Wireless Application", Wiley, 2000
- [15] R.A. Pucel, H.A. Haus, H. Statz, "Signal and Noise Properties of Gallium Arsenide Microwave Field-Effect Transistors," in Advances in Electronics and Electron Physics, Vol. 38, Academic Press, 1975.
- [16] U.L. Rohde, "New Nonlinear Noise Model for MESFETS Including MM-Wave Application," First International Workshop of the West German IEEE MTT/AP Joint Chapter on Integrated Nonlinear Microwave and Millimeterwave Circuits (INMMC'90) Digest, October 3–5, 1990, Duisburg University, Duisburg, Germany.
- [17] U.L. Rohde, "Improved Noise Modeling of GaAs FETS: Using an Enhanced Equivalent Circuit Technique," Microwave Journal, pp. 87–101, November 1991; pp. 87–95, December 1991.
- [18] M. Rudolph, R. Doerner, K. Beilenhoff, P. Heymann, "Scalable Gain/GaAs HBT Large-Signal Model," IEEE Transactions on Microwave Theory and Techniques, Vol. 48, pp. 2370–2376, December 1990.
- [19] R.A. Pucel, W. Struble, R Hallgren, U.L. Rohde, "A General Noise De-embedding Procedure for Packaged Two-Port Linear Active Devices," IEEE Transactions on Microwave Theory and Techniques, Vol. 40, No. 11, pp. 2013–2024, November 1992.
- [20] Ulrich L. Rohde, Anthony M. Pavio, and Robert A. Pucel, "Accurate Noise Simulation of Microwave Amplifiers Using CAD", Microwave J, 31(12), 130-141, December 1988.

- [21] R.A. Pucel, U.L. Rohde, "An Exact Expression for the Noise Resistance R_n of a Bipolar Transistor for Use with the Hawkins Noise Model," IEEE Microwave and Guided Wave Letters, Vol. 3, No. 2, pp. 35–37, February 1993.
- [22] C.C. McAndrew, J.A. Seitchik, D.F. Bowers, M. Dunn, M. Foisy, I. Getreu, M. McSwain, S. Moinian, J. Parker, D.J. Roulston, M. Schroeter, P. van Wijnen, L.F. Wagner, "VBIC95, The Vertical Bipolar Inter-Company Model," IEEE Journal of Solid-State Circuits, Vol. 31, No. 10, pp. 1476–1483, October 1996.
- [23] W. Anzill, F.X. Kaertner, P. Russer, "Simulation of the Single-Sideband Phase Noise of Oscillators," Second International Workshop of Integrated Nonlinear Microwave and Millimeterwave Circuits, 1992.
- [24] U.L. Rohde, Anisha Apte, "Everything You Always Wanted to Know about Colpitts Oscillators," IEEE Microwave Magazine, vol. 17, issue 8, pp. 59-76, Aug. 2016.
- [25] U.L. Rohde, "Parameter Extraction for Large Signal Noise Models and Simulation of Noise in Large Signal Circuits Like Mixers and Oscillators," 23rd European Microwave Conference, Madrid, Spain, September 6–9, 1993.